

Coffee System

TANGO ACEMT, 1 group full-automatic machine with Cappuccinatore

ITEM # _____

MODEL # _____

NAME # _____

SIS # _____

AIA # _____



602560 (TANGOACEMTLC) Full-automatic machine, 1 group, 220x40 ml espresso cup/hr, 6,5 liter steam/coffee boiler, 1x1,7 kg coffee hopper for beans, 0,8-1,5 kg hopper for powder, programmable water, Tango Cappuccinatore device with double function L: for hot milk and C: for foam by air injection

Short Form Specification

Item No.

The super automatic multi-products Tango® ACE MT fully takes advantage of the exceptional extraction quality that has established the reputation of the TANGO® range, and the ability to work with powdered products such as cocoa.

The 48 hot drinks menu , for breakfast or gourmet coffee breaks along the day, is fully programmable through the 7" touch screen interface.

To fulfill this entire drinks menu, the Tango® ACE MT can be fitted with the Cappuccinatore device to process fresh milk, into specialty coffee drinks as cappuccinos, lattes, mochas...

Delivery Capacity:

Espresso 40ml: 220 cups/h

Lungo 100ml: 150 cups/h

Hot chocolate 250ml: 110 cups/h

Cappuccino 100ml: 170 cups/h

Latte 100ml: 150 cups/h

Latte macchiato 300ml: 80 cups/h

Hot Water: 30 L/h

Main Features

- 1 group full-automatic machine.
- 6.5 liter steam/coffee boiler.
- Auto cleaning program.
- Programmable water and steam.
- Tango Cappuccinatore device with double feature L: for hot milk and C: for foam by air injection.
- The 48 hot drinks menu , for breakfast or gourmet coffee breaks along the day, is fully programmable through the 7" touch screen interface.
- The super automatic multi-products Tango® ACE MT fully takes advantage of the exceptional extraction quality that has established the reputation of the TANGO® range, and the ability to work with powdered products such as cocoa.
- To fulfill this entire drinks menu, the Tango® ACE MT can be fitted with the Cappuccinatore device to process fresh milk, into specialty coffee drinks as cappuccinos, lattes, mochas...
- Delivery Capacity:
 Espresso 40ml: 220 cups/h
 Lungo 100ml: 150 cups/h
 Hot chocolate 250ml: 110 cups/h
 Cappuccino 100ml: 170 cups/h
 Latte 100ml: 150 cups/h
 Latte macchiato 300ml: 80 cups/h
 Hot Water: 30 L/h

Construction

- 1 x 1,7 kg coffee hopper & grinders + (0,8 at 1,5) kg hopper for powder.

Optional Accessories

- Side milk refrigerator 8 liter nominal capacity for up to 4 liter milk containers PNC 871014
- Side milk refrigerator 8 liter nominal capacity for up to 4 liter milk containers with digital display PNC 871015
- TANGO hotel/breakfast service kit PNC 871022
- Coffee ground direct discharge chute PNC 871023
- Raised feet kit PNC 871041

APPROVAL: _____



Electrolux
PROFESSIONAL

Coffee System TANGO ACEMT, 1 group full-automatic machine with Cappuccinatore

Front

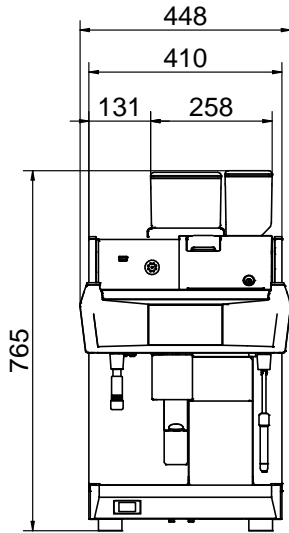

Side

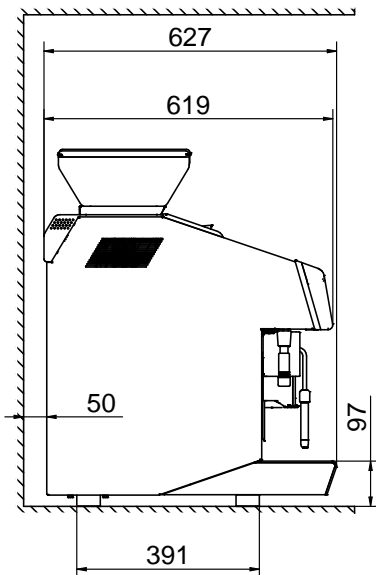

Top

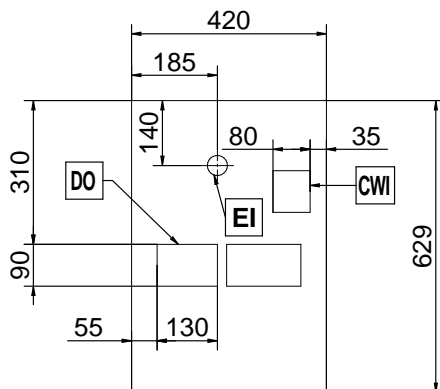

Electric

Supply voltage:

602560 (TANGOACEMTLC) 400 V/3N ph/50 Hz

Electrical power max.:

5.2 kW

Plug type:

Cable without plug

Water:

Cold water temperature

(min/max): 5 / 60 °C

Key Information:

External dimensions, Width: 448 mm

External dimensions, Depth: 627 mm

External dimensions, Height: 846 mm

Net weight: ISO 9001; ISO 14001; ISO 45001; ISO 50001 kg

Shipping volume: 0.69 m³

Sustainability

Current consumption: 7.5 Amps

Coffee System
TANGO ACEMT, 1 group full-automatic machine with Cappuccinatore

The company reserves the right to make modifications to the products without prior notice. All information correct at time of printing.

2024.07.03

